



NORTH SHORE SAFETY



**Installation, Testing, and Operating Procedures
15 AMP PLUG SERIES**

IMPORTANT!

Please read all the information on this sheet.

SAVE THESE INSTRUCTIONS!

NOTICE

BEFORE USING READ INSTRUCTIONS COMPLETELY. TO BE INSTALLED BY A QUALIFIED ELECTRICIAN IN ACCORDANCE WITH NATIONAL AND LOCAL ELECTRICAL CODES AND THESE INSTRUCTIONS.

CAUTION!

RISK OF ELECTRIC SHOCK, BURN, OR EXPLOSION. DISCONNECT POWER BEFORE INSTALLING. NEVER WIRE ENERGIZED ELECTRICAL COMPONENTS. FAILURE TO DO SO MAY CAUSE SEVERE SHOCK, PERSONAL INJURY, OR DEATH.

WARNING!

- Ground Fault Circuit Interrupter (GFCI) is a safety device under normal use and is not intended to promote activity of elevated risk.
- Do not use this GFCI if it fails to function as instructed. Never attempt to tamper with this device.
- This GFCI should never be used as a switch to connect or disconnect power. (Power should be disconnected at main power feed or by a secondary switch located at the primary feed of GFCI.)
- This GFCI is not an over current protection device. (An appropriate current breaker should be used in series at primary power feed.)

CAUTION!

- Do not use this device to feed power to Life Support apparatus.
- To minimize nuisance tripping: do not use this device on swimming pool equipment installed prior to 1965 NEC code, limit load cable to 250 feet and do not use on electric dryers and ranges with frames grounded by Neutral conductor.

NOTICE

- A GFCI is a device designed to interrupt power when a ground fault exceeds a predetermined value. The interruption of power is fast in order to prevent injuries. The human body is conductive to electricity. Any electrical apparatus is a potential shock hazard when used near wet locations.
- The GFCI constantly monitors the current balance of the conductors supplying power to the load. When a ground fault occurs, by leakage or by shock, the imbalance of current is sensed and the GFCI trips when the ground fault exceeds 0.006 Amps. Consult NSS about higher trip threshold ELCIs.

WARNING!

A GFCI CANNOT DO THE FOLLOWING:

- Will not protect line side
- Will not protect you when touching two current carrying conductors of opposite polarity (GFCI recognizes this as a load)
- Will not protect you when touching a line of another circuit
- Will not detect or interrupt overcurrent

NORTH SHORE SAFETY'S TWO-YEAR LIMITED MANUFACTURER'S WARRANTY

North Shore Safety warrants to the consumer its offering of LineGard Ground Fault Circuit Interrupters (GFCIs) to be free from defects in materials and workmanship under normal use and service for a period of two years from the manufacture date. North Shore Safety, at its option will repair or replace the defective GFCIs without charge within a two year period from the date of manufacture, provided that the defect occurred during normal use and was installed according to all published instructions. All returns must be authorized by a North Shore Safety representative. In the event of product failure please contact a North Shore Safety representative at 1-440-205-9188 to obtain a Return Goods Authorization Number (RGA) prior to returning any product to North Shore Safety. North Shore Safety will refuse any item if prior Return Goods Authorization has not been granted. Defective units must be returned prepaid freight, with a description of the problem, and with an attached RGA number referenced to the Quality Assurance Dept., North Shore Safety, Ltd., 7335 Production Drive, Mentor, OH 44060. Determination of Warranty compliance is solely at the discretion of North Shore Safety and North Shore Safety's disposition is final.

Disclaimer

North Shore Safety will not be liable, directly or indirectly, for any cost whatsoever associated with installation or removal of any device, or for any personal injury, property damages, or incidental, indirect, or consequential damages of any kind whatsoever as a result of any defective device. The exclusive remedy under this Warranty is the repair or replacement of the defective device. In no case shall North Shore Safety's liability exceed the net purchase price. This Warranty is void if the device is not properly installed, tampered with, opened, abused, or not used according to label instructions and ratings, and/or published specifications.



WIRING INSTRUCTIONS

INSTALLATION INSTRUCTIONS:

1. REMOVE SCREWS AS SHOWN IN STEP # 1
2. REMOVE COVER TO EXPOSE TERMINAL STRIP (SEE STEP #2)
3. BACK TERMINAL SCREWS OFF TO ACCEPT WIRES
4. PREPARE CABLE TO STEP # 4 DRAWING (SEE NOTE #2 ON ACCEPTABLE CABLE TYPES)
5. APPLY CORD GROMMET (SEE TABLE FOR SIZE): USE OF HAND SOAP WILL ASSIST INSTALLATION
6. INSERT WIRES INTO TERMINAL STRIP AS SHOWN IN STEP #6 (MUST BE CORRECT ORIENTATION) THEN SECURE SCREW TERMINALS (8 in/lbs)
7. LOAD CABLE AND GROMMET TO HOUSING SLOT AS SHOWN IN STEP # 7
8. SECURE CORD ASSEMBLY TO HOUSING WITH CABLE STRAIN RELIEF (SEE STEP # 8) (8 in/lbs)
9. REINSTALL HOUSING COVER WITH SCREWS SHOWN IN STEP # 1 AND # 9 (8 in/lbs)
10. TEST PER TESTING AND TROUBLESHOOTING PROCEDURE (SEE STEP #10)

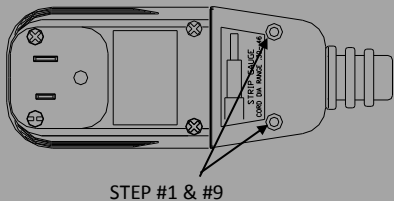
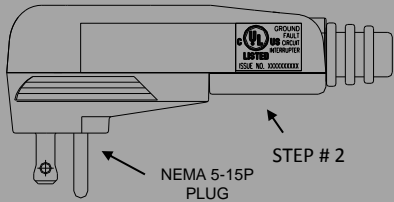
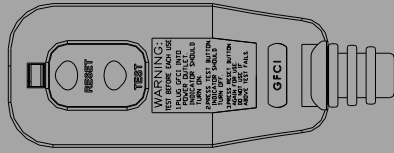

STEP # 10

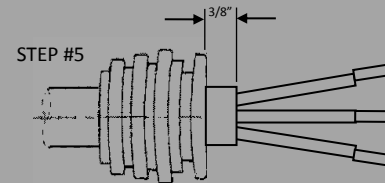
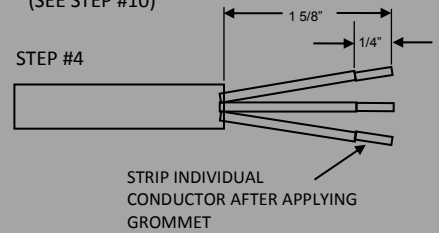
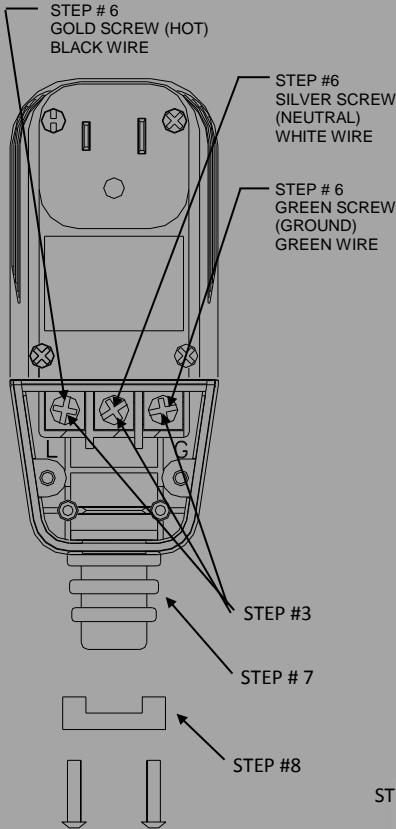

GROMMET	DIAMETER	CABLE
A	.32"	18-3
B	.35"	16-3 & 14-3
C	.38"	12-3

NOTE: CORD GAGE SELECTION SHOULD BE IN ACCORDANCE WITH NEC STANDARDS ON CORD GAGE AMPACITY

TESTING AND TROUBLESHOOTING PROCEDURE

1. Apply rated power to GFCI.
2. Press and release RESET button, GREEN LED should turn ON and appear in window above reset button. (For Auto Power-Up model, GREEN LED will automatically turn on and appear in window when power is restored.)
3. Press Test Button, GREEN LED (Power) turns off and disappears from window. Press and release reset button, GREEN LED turns on and reappears in window.
4. CHECKING FOR CORRECT WIRING:
 - If GFCI is wired to protect a cord receptacle, plug a household lamp into the protected cord receptacle. Press and release the RESET button, lamp should turn on. Press the TEST button. Lamp should turn off. If lamp stays on when pressing TEST button, or if lamp does not illuminate when pressing RESET button, unplug GFCI, check and correct your wiring connections. Repeat steps 1-4. If problem persists, do not use this GFCI. Consult a qualified electrician for assistance or replacement.
 - If GFCI is wired to protect equipment, press and release RESET button. Verify that equipment power is on. Press TEST button. Equipment power should turn off. If equipment power does not come on when pressing and releasing RESET button, or if power stays on when pressing TEST button, unplug GFCI, check and correct your wiring connections. Repeat steps 1-4. If problem persists, do not use this GFCI. Consult a qualified electrician for assistance or replacement.

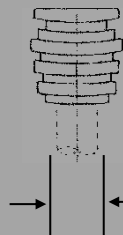

LISTED:	U.L. and c U.L. (U.L.943)
RATED SUPPLY VOLTAGE:	120 VAC
RATED CURRENT:	UP TO 15 AMPS OR CABLE OR WIRING DEVICE RATING
RESET TYPE:	AUTOMATIC OR MANUAL
OPERATING FREQUENCY:	60 Hz
TYPE:	CLASS A
GROUND TRIP CURRENT:	BETWEEN 4-6 mA
OVERLOAD CURRENT:	90 AMP 125 VAC (25 CYCLES)
INSULATION VOLTAGE:	1,500 VRMS – 1 MINUTE
ENDURANCE OPERATIONS:	3000 OPERATIONS AT RATED LOAD

- NOTE:**
- 1) MANUAL CONFIGURATION SHOULD BE SPECIFIED WHEN AUTOMATIC POWER-UP WOULD CREATE AN UNSAFE CONDITION AFTER RESTORATION OF CIRCUIT POWER.
 - 2) CABLE MUST BE INDOOR / OUTDOOR 3-CONDUCTOR CABLE OF TYPE, ST, SJT, SE, SJE, SO or SJO.